

RADIAL FAN WITH FORWARD CURVED BLADES

Радиальный вентилятор с вперед загнутыми лопатками

Radialventilator mit vorwärts gekrümmten Schaufeln

Wentylator promieniowy z łopatkami pochylonymi do przodu



MOTOR TYPE / Тип двигателя / Motortyp / Typ silnika:	R2E 140-AR87-43
VOLTAGE / Напряжение / Spannung / Napięcie znamionowe:	230 V~ 50 Hz
MAXIMUM PRESSURE / Полное давление / Maximaler Druck / Spręż max.:	280 Pa
MAX. AIR FLOW / Макс. производ. / Max Luftfördermenge / Wydatek max.:	180 m ³ /h
SPEED / Частота вращения / Drehzahl / Prędkość obrotowa:	1650 rpm
POWER INPUT / Входная мощность / Leistungsaufnahme / Moc pobierana:	34 W
WEIGHT / Масса / Gewicht / Masa:	2.10 kg
PERM. AMB. TEMP. / Zuläs.Umgeb. Temp. / Допуст. темп. среды / Dop. temp. otoczenia:	-25°C do +40°C
MATERIAL OF IMPELLER / Материал ротора / Laufradmaterial / Materiał wirnika:	GALVANIZED STEEL / оцинкованная сталь / verzinkter Stahl / stal cynkowa
HOUSING / Gehäuse / Корпус / Obudowa:	ALUMINUM / Aluminium / Алюминий / Aluminiowa
FLANGE / Фланец / Flansche / Kołnierz:	

SIZE AND HOLES CAN BE ADAPTED TO THE REQUIREMENTS / Размер и отверстия могут быть адаптированы к требованиям / Größe und Bohrungen kann den Anforderungen angepasst werden / Rozmiar i otwory mogą być dostosowane do wymagań

ALTERNATIVE FLANGE / Альтернативный фланец / Alternative Flansch / Alternatywny kołnierz:

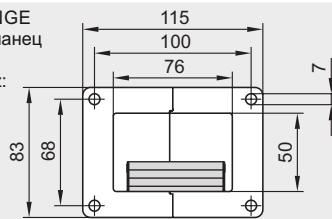

WPA HL 117 /G2E

FAN DIMENSIONS / Размеры вентилятора / Lüfterabmessungen / Wymiary wentylatora:

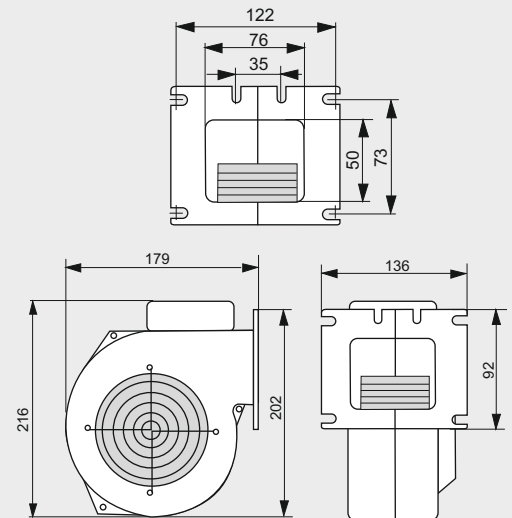

CONNECTION DIAGRAM / Схема подключения / Anschlussbild / Schemat połączenia:



CURVES / Характеристика / Curves / Charakterystyka:

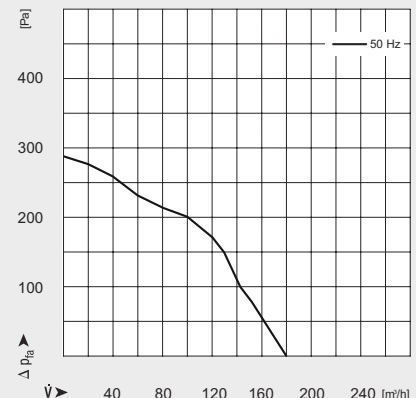

Valve / Заслонка / Klappe / Klapka:



KZW (normal valve)

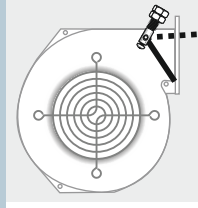

The valve with the largest coverage area of the outlet.

In the open position, sticking out a bit out of the housing.

Klapka o największej powierzchni krycia wylotu.

W pozycji otwartej wystaje poza obudowę.

KGL (deep valve)

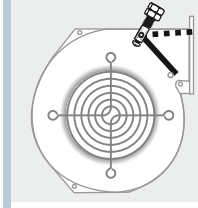

The valve with the average coverage area of the outlet.

In the open position, does not sticking out of the housing.

Klapka o średniej powierzchni krycia wylotu.

W pozycji otwartej nie wystaje poza obudowę.

Terminal box / Клеммная коробка / Schaltschrank / Puszka elektryczna:

Housing painted / Корпус окрашен / Cover lackiert / Malowana obudowa:

Upper assembly, with IEC and RJ sockets

black semi-gloss, powder coating



GPGN (W1)

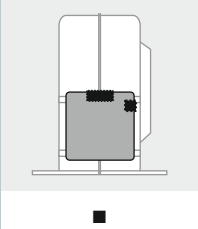

GPGN (W2)

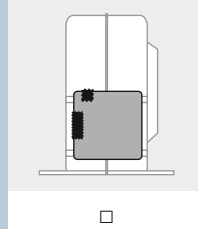

GPGN (W3)

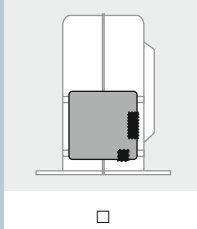

M



Side assembly, with IEC and RJ sockets

Gasket / Уплотнение / Dichtung / Uszczelka:

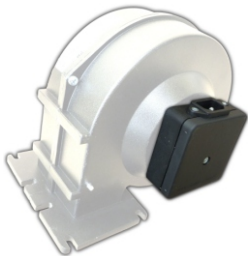

BPGN (W1)

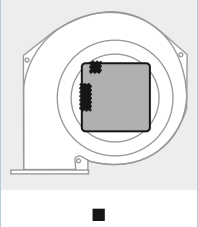

BPGN (W2)

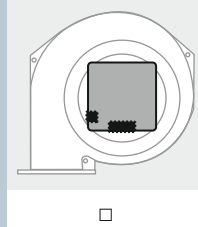

BPGN (W3)

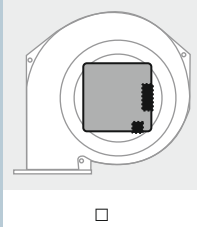

BPGN (W4)

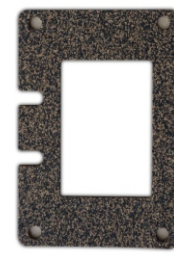
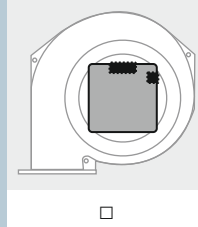

U

flange gasket made of cork-rubber blend

Electrical and control connections

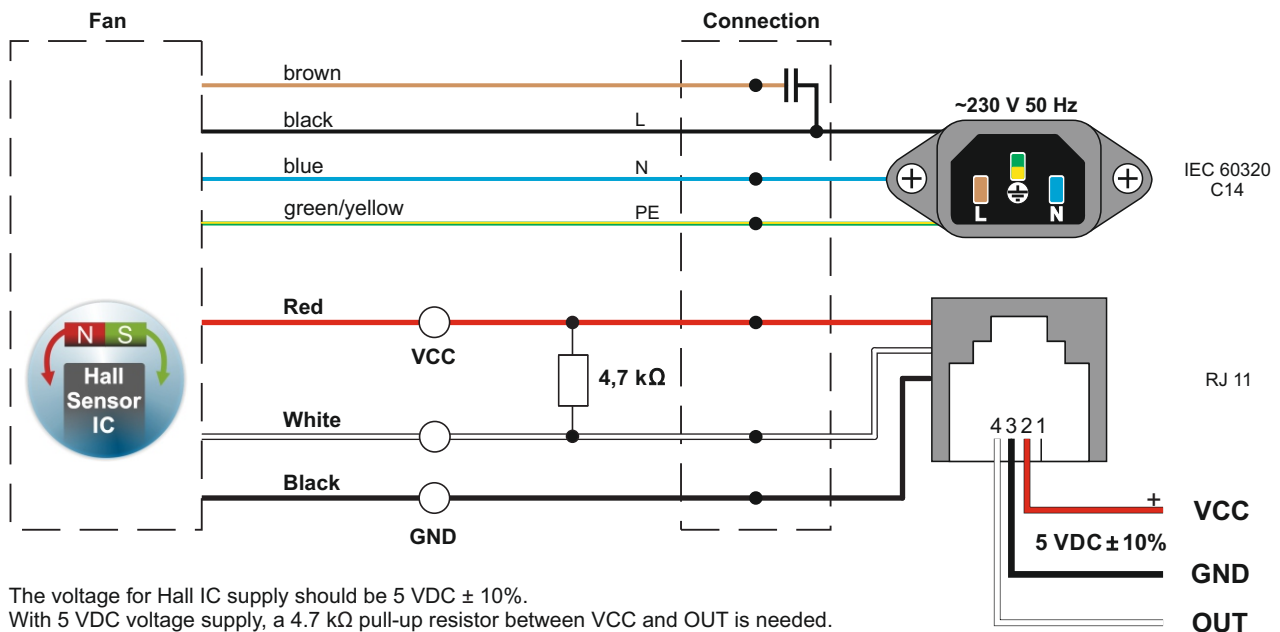

The voltage for Hall IC supply should be 5 VDC ± 10%.
With 5 VDC voltage supply, a 4.7 kΩ pull-up resistor between VCC and OUT is needed.